

Data sheet | Item number: 756-3205/140-150

Connecting cable; for the connection of M8 sensor/actuator boxes; 14-pole;
M16 socket, straight; one free cable end; 15 m

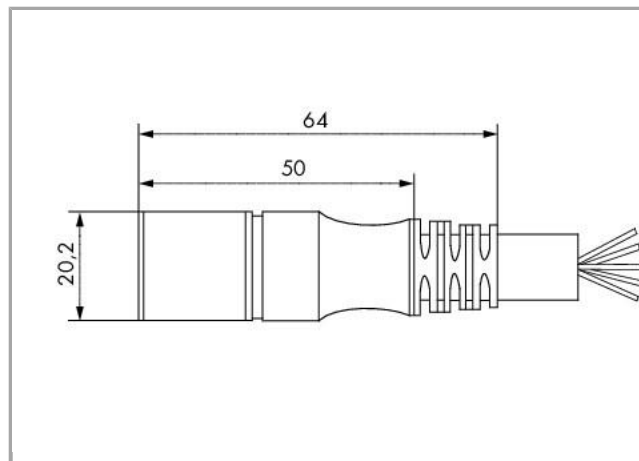

756-3205/140-150



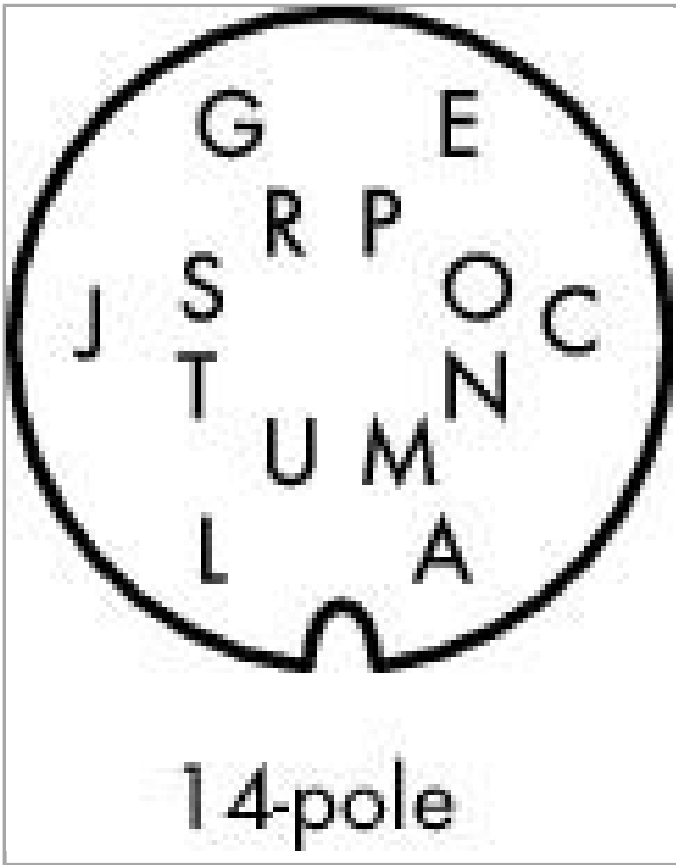

Pin A, L: 0.75 mm²
 Pin C - J, N - T: 0.34 mm²

A	brown	N	pink-brown
C	white-pink	O	violet
E	black	P	white
G	pink	R	red
J	green	S	gray
L	blue	T	yellow
M	commoned with A	U	commoned with L

Data

Technical Data

Connection type	M16 socket - free end
No. of poles	14
Leitungsanschlussrichtung zur Steckrichtung	0°
Cable length	15 m
Operating voltage	150 V
Operating current	4 A
Operating current	6 A (0,75 mm ²)
Rated surge voltage	1,2 kV

Mechanical data

Bending cycles	2 Mio.
Schleppkettentauglichkeit	yes
Durchmesser der Mantelleitung	8.9 ... 9.3 mm
Weight	1753 g

Environmental Requirements

Umgebungstemperatur (Betrieb) bewegt	-30 ... +90 °C
--------------------------------------	----------------



Umgebungstemperatur (Betrieb) ruhend	-40 ... +90 °C
Protection class	IP67

Commercial data

Country of origin	DE
GTIN	4044918978521
Customs Tariff No.	85444290900

Downloads

Documentation

System Description

Sensor/Actuator Boxes – General Product Information	pdf 537.3 kB	Download
---	-----------------	----------

Subject to changes.
